

T 2000

Transformer test set

- **Multi function system for testing substation equipment such as: current, voltage and power transformers, over-current protection relays, energy meters and transducers**
- **Primary injection testing capabilities**
- **3000 V AC high-pot test**
- **Generates up to 800 A (option: 2000 - 3000 - 4000 A)**
- **Microhmmeter function (option): up to 400 A DC**
- **Large graphic display**
- **Test results and settings are saved in the local memory**
- **RS232 interface for PC connection**
- **Compact and lightweight**

T 2000 is a unique solution for all testing operations during commissioning and maintenance of substations, as it allows to perform the test of over-current relays, current and voltage transformers. In addition, T 2000 incorporates a powerful multi-meter and phase angle meter, and oscilloscope functions.

A P P L I C A T I O N

The following table lists the tests that can be performed on Current Transformers (CT) and Voltage Transformers (VT), Power Transformer (PT), Ground Grid.

N.	TEST	TEST DESCRIPTION
1	CT	Ratio, Voltage mode
2	CT	Ratio, polarity and burden, Current mode
3	CT	Burden; secondary side
4	CT	Excitation curve
5	CT	Winding or burden resistance
6	CT	Voltage withstand
7	CT	Polarity by impulses
8	VT	Ratio; polarity
9	VT	Burden, secondary side
10	VT	Ratio, electronic transformers
11	VT	Voltage withstand
12	VT	Secondary over-current protection
13	PT	Ratio per TAP
14	PT	Static and dynamic TAP Changer resistance test
15	GR	Earth resistance
16	GR	Soil resistivity



The table below lists the relays that can be set and tested by T 2000.

RELAY TYPE	IEEE NO	OTHER DEVICES
Thermal	26	Timers
Over/under-voltage	27/59	Transducers
Under current	37	Energy meters
Instantaneous overcurrent	50	
Ground fault	50N	
Timed overcurrent	51	
Circuit breaker	52	
Differential (pick-up)	87	
Tripping relay	94	

Typical application Test of Current Transformer

- CT RATIO AND POLARITY - VOLTAGE METHOD
OUTPUT: 90V, 250V or 3000 V AC.
MEASUREMENT: 10 V AC.

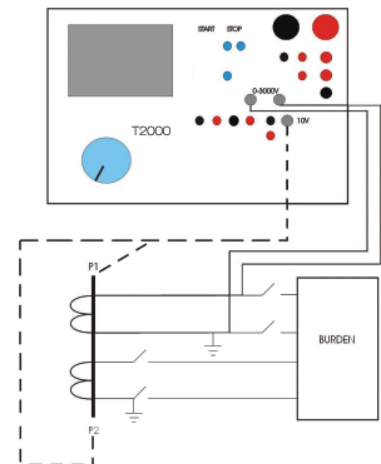
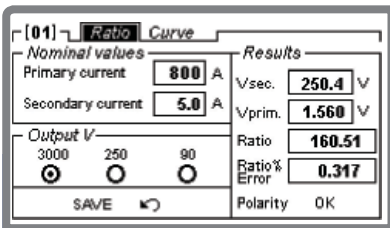

- CT RATIO, POLARITY AND BURDEN – CURRENT METHOD
OUTPUT: 800 A AC.
MEASUREMENTS: 10 A AC, 10 V AC.

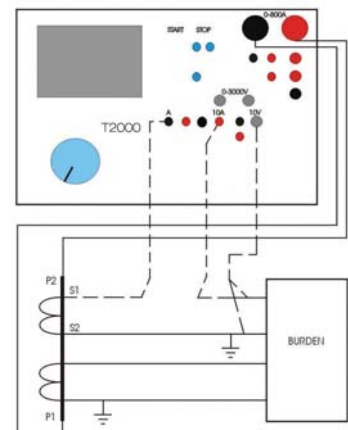
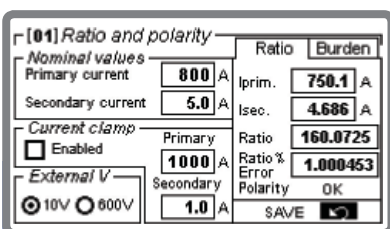

- CT BURDEN SECONDARY SIDE:
OUTPUT: 10 A or 40 A AC.
MEASUREMENT: 10 V AC.

[01] Burden secondary side	
<i>Nominal values</i>	
Secondary current	5.5 A
<i>Output Current Range</i>	
<input checked="" type="radio"/> 10A <input type="radio"/> 40A	
<i>Results</i>	
I rms	5.0 A
V rms	5.0 V
φ	0.0 °
P.f.	1.0
VA	25.0
SAVE	

- CT EXCITATION CURVE
OUTPUT: 90V, 250V or 3000 V AC.
Internal measurement.

[01] Ratio Curve	
<i>Nominal values</i>	
VA rating	100 VA
Secondary current	1.0 A
Accuracy limit	5
Internal loss	1 VA
Accuracy class	5 P
Standard	IEC
<i>Nominal knee</i>	
I knee	250.0 mA
V knee	505 V
<i>Output V</i>	
<input checked="" type="radio"/> 3000 <input type="radio"/> 250 <input type="radio"/> 90	
SAVE	

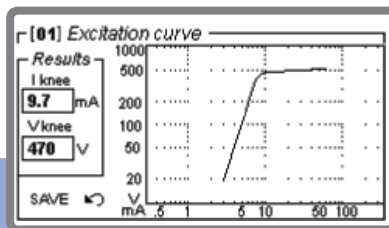

- WINDING RESISTANCE
OUTPUT: 6 A DC.
MEASUREMENT: 10 V DC.

[01] Winding or burden resistance	
<i>Temperature compensation</i>	
Ambient temperature Reference temperature	
<input type="checkbox"/> Enabled <input type="checkbox"/> Disabled	
<input checked="" type="radio"/> Fahrenheit (°F) <input checked="" type="radio"/> Celsius (°C)	
<i>Results</i>	
I dc	4.14 A
V dc	0.507 V
Res.	0.122
Comp. Res.	0.122
SAVE	

- VOLTAGE WITHSTAND
OUTPUT: 3000 V AC.
Internal measurement.

[01] Voltage withstand	
<i>Maximum values</i>	
Max V	2000 V
Max I	20 mA
<i>Results</i>	
IAC	8.00 mA
VAC	1700 V
Elapsed time	56.4 s
SAVE	

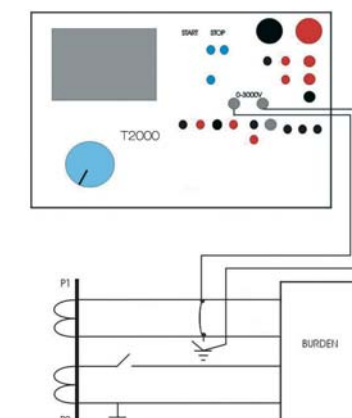
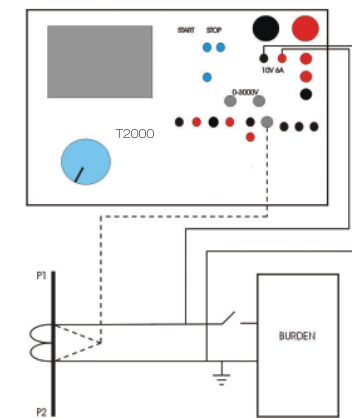
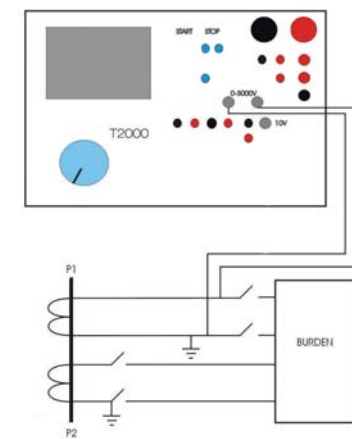
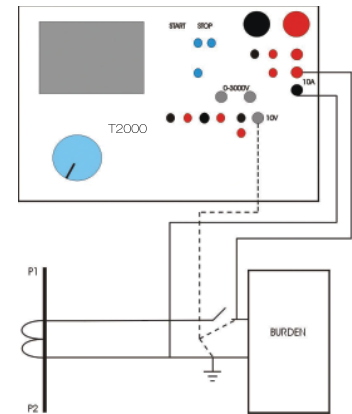

Typical application

Test of Voltage Transformer

- VT RATIO AND POLARITY**

OUTPUT: 3000 V AC.

MEASUREMENT: LOW or HIGH AC VOLTAGE - 10 V AC OR 600 V AC.

Ratio and polarity	
<i>Nominal values</i>	
Primary voltage	130.0 kV
<input checked="" type="radio"/> LL <input type="radio"/> LN	
Secondary voltage	100 V
<input checked="" type="radio"/> LL <input type="radio"/> LN <input type="radio"/> Vo	
<input checked="" type="radio"/> Ext V10V <input type="radio"/> Ext V600V	
<i>Results</i>	
Vprim.	2600 V
Vsec.	1.985 V
Ratio	1309.8
Ratio % Error	1.0075
Polarity	OK
SAVE	

- VT BURDEN**

OUTPUT: 10 A AC.

MEASUREMENT: LOW or HIGH AC VOLTAGE - 10 V AC OR 600 V AC.

Burden secondary side	
<i>Nominal values</i>	
Secondary voltage	100 V
<input checked="" type="radio"/> LL <input type="radio"/> LN <input type="radio"/> Vo	
<i>Measurement V</i>	
Internal	Ext V600V
Ext V10V	
<i>Results</i>	
I _{rms}	0.15 A
V _{rms}	57.80 V
φ	9.9 °
P.f.	0.985
VA	8.67
SAVE	

- VOLTAGE WITHSTAND**

OUTPUT: 3000 V AC.

Internal measurement.

Voltage withstand	
<i>Maximum values</i>	
Max V	2000 V
Max I	20 mA
<i>Results</i>	
IAC	2.3 mA
VAC	1350 V
Elapsed time	45.9 s
SAVE	

- RATIO OF ELECTRONIC VOLTAGE TRANSFORMERS**

OUTPUT: 3000 V AC.

MEASUREMENT: 10 V AC.

Electronic voltage transformer	
<i>Nominal values</i>	
Primary voltage	10000 V
<input checked="" type="radio"/> LL <input type="radio"/> LN	
Secondary voltage	1.00 V
<input checked="" type="radio"/> LL <input type="radio"/> LN <input type="radio"/> Vo	
<input checked="" type="radio"/> Ext V10V <input type="radio"/> Ext V600V	
<i>Results</i>	
V _{prim.}	2500 V
V _{sec.}	0.255 V
Ratio	9803
Ratio % Error	2.00
Polarity	OK
SAVE	

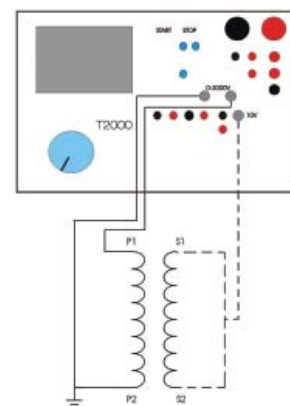
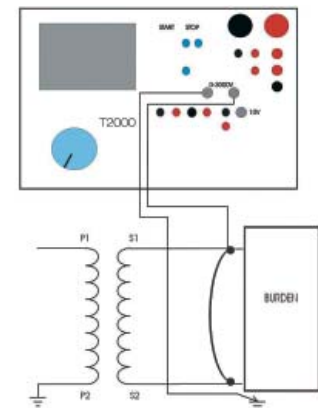
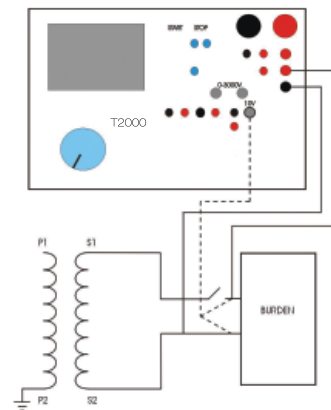
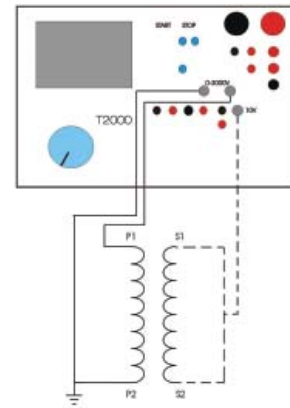

Typical application Power Transformer

- RATIO PER TAP**

OUTPUT: 3000 V AC.

MEASUREMENT: LOW or HIGH AC VOLTAGE - 10 V AC OR 600 V AC.

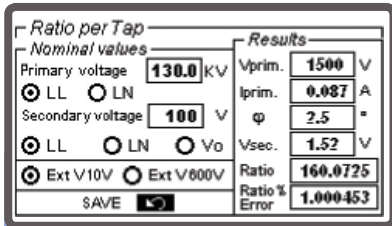

- STATIC AND DYNAMIC TAP CHANGER RESISTANCE TEST**

OUTPUT: 6 A DC.

MEASUREMENT: 10 V DC.

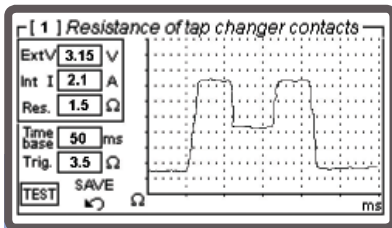

Typical application Relay Testing

- PRIMARY INJECTION**

OUTPUT: 800 A.

INPUT: TIMER.

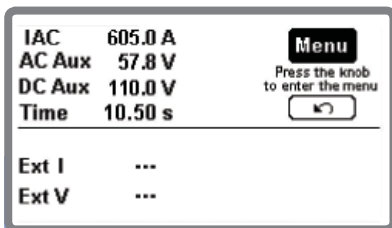

- SECONDARY INJECTION**

OUTPUT: 800 A, 40 A or 10 A.

INPUT: TIMER.

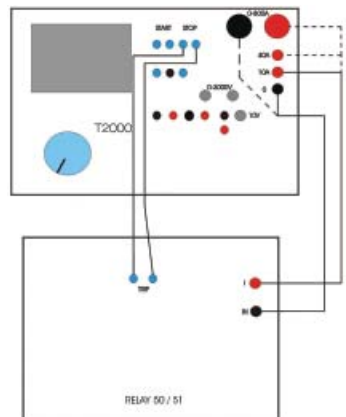
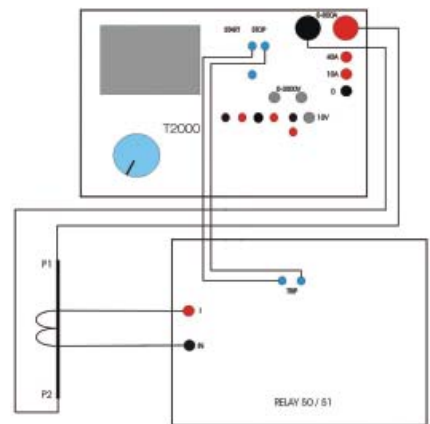
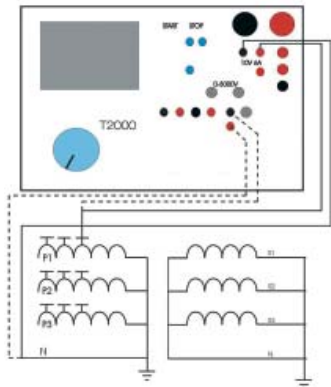
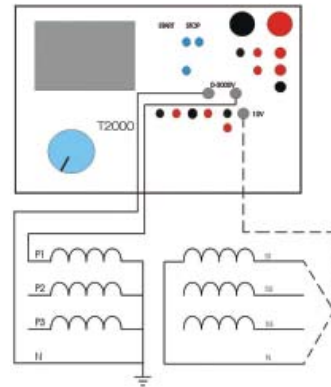
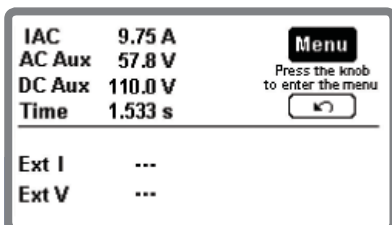

SYSTEM DESCRIPTION

T 2000 includes a multiple generator, with six outputs: High AC current; Low AC current; Low DC current; Current impulses; High AC voltage; Low AC voltage.

The selected output is adjustable and metered on the large, graphic LCD display. With the multi-purpose control knob and the graphic LCD display it is possible to enter the MENU mode, that allows to control all functions, and makes T 2000 the most powerful testing device, with manual and automatic testing capabilities, and with the possibility to transfer test results to a PC via the RS232 interface. These results can be recorded, displayed and analysed by the powerful TDMS software, which operates with all WINDOWS versions, starting from WINDOWS 98 included.

Note: WINDOWS is a trademark of MICROSOFT inc.

Additional features are:

- . Oscilloscope function: it is possible to display the current and voltage waveform measured;
- . Two independent measurement inputs, for current and voltage, and with High and Low inputs each, allow measuring CT or VT outputs or any other source;
- . The optional thermal printer gives the immediate printout of the CT saturation curve and other test results;

The instrument is housed in a transportable aluminium box, which is provided with removable cover and handles for ease of transportation.

T 2000 Specification

The generator has six outputs: High AC current; Low AC current; Low DC current; Current impulses; High AC voltage; Low AC voltage. Output adjustment is performed via a knob. The following specification applies to the separate usage of these outputs.

High AC current output

APPLICATION:

- . CT TESTING: RATIO, POLARITY, BURDEN
- . PRIMARY INJECTION
- . RELAY TESTING: ELECTRO-MECHANICAL (HIGH POWER) AND NUMERIC (LOW POWER)

CURRENT OUTPUT A	OUTPUT POWER VA	LOAD TIME s	RECOVERY TIME min
100	600	steady	-
150	800	15 min	30
200	1000	4 min	15
400	1600	15	5
600	2000	5	3
800	2000	1	2

Low AC current output

APPLICATION:

- . CT TESTING: BURDEN, SECONDARY SIDE
- . VT TESTING: OVERCURRENT PROTECTION
- . OVER-CURRENT RELAY TESTING

HIGH POWER RANGE

RANGE A AC	CURRENT OUTPUT A	OUTPUT POWER VA	MAX TEST DURATION s	RECOVERY TIME min
40	12	300	steady	-
	18		15 min	30
	24		4 min	15
	36	800	15	5
	48		5	3
	60	1000	1	2
10	5	400	steady	-
	7.5		15 min	30
	10	800	60	15
	15		30	10
	20	1000	15	5

LOW POWER RANGE

RANGE A AC	CURRENT OUTPUT A	OUTPUT POWER VA	MAX TEST DURATION s	RECOVERY TIME min
40	12	60	steady	-
	17		10 min	30
	23		60	10
	36		1	2
10	5	60	steady	-
	6		10 min	45
	7		60	2
	10		1.5	2

Low DC current output

APPLICATION:

- . CT TESTING: WINDING RESISTANCE, BURDEN RESISTANCE
- . PT TESTING: TAP-CHANGER CONTACT RESISTANCE

CURRENT OUTPUT A	LOAD RESISTANCE Ohm	OUTPUT POWER VA	MAX TEST DURATION min
6	0	0	steady
3	2	18	steady
1	8	8	steady

Current impulses output

APPLICATION:

- . CT TESTING: POLARITY TEST WITH IMPULSE METHOD
 - Current range: from 0 to 10 A peak.

High AC voltage output

Two version are available: 3000V or 1200V output.

APPLICATION:

- . CT TESTING: EXCITATION CURVE, VOLTAGE WITHSTAND
- . VT TESTING: RATIO, POLARITY, ELECTRONIC VOLTAGE TRANSFORMER
- . PT TESTING: RATIO PER TAP

3000 V version

- . APPLICATION: 1A CT'S

VOLTAGE OUTPUT V	CURRENT OUTPUT A	OUTPUT POWER VA	MAX TEST DURATION min
3000	0.2	600	steady
2500	0.6	1500	1

IN ALTERNATIVE

1200 V version

- . APPLICATION: 5A CT'S

VOLTAGE OUTPUT V	CURRENT OUTPUT A	OUTPUT POWER VA	MAX TEST DURATION min
1200	0.5	600	steady
1200	1.5	1800	1

Low AC voltage output

APPLICATION:

- . CT TESTING: RATIO WITH VOLTAGE METHOD, SATURATION CURVE

VOLTAGE OUTPUT V	CURRENT OUTPUT A	OUTPUT POWER VA	MAX TEST DURATION min
250	0.5	125	steady
220	1.15	250	3

Timer

Available measurements:

- Timer start: at test start, or by an external contact;
- Metering of elapsed time between START and STOP;
- Current generation elapsed time.
- Time can be metered as seconds or cycles.
 - . Inputs: free of voltage or with voltage.
 - . Programmable voltage threshold: 24 V or 80 V.
 - . Metering range, in seconds: from 0 to 9.999 s; 10.00 to 99.99 s; 100.0 to 999.9 s; 1000 to 9999 s.
 - . Metering range, in cycles: from 0 to 1000.0 cycles; from 1000 to 500,000 cycles
- Counting mode: this mode is foreseen for the test of energy meters. Maximum input frequency: 10 kHz.

Auxiliary binary Output

Contact range: 5 A; 250 V AC; 120 V DC.

Measuring Section

Output measurements

Current and voltage AC and DC outputs measurement accuracy: $\pm 0.5\%$.

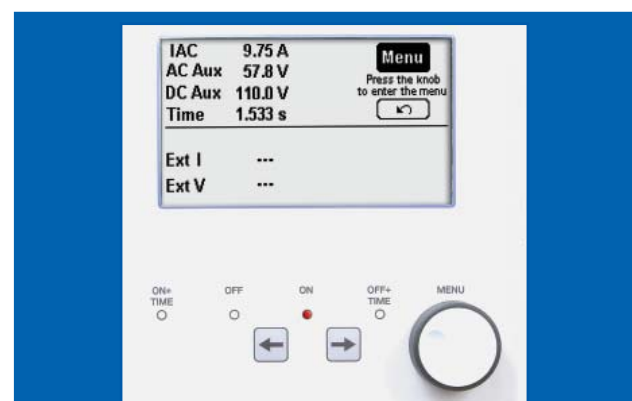

The following measurements are calculated from T 2000 generated outputs:

OUTPUT MEASUREMENTS:	
ACTIVE POWER	P
REACTIVE POWER	Q
APPARENT POWER	S
POWER FACTOR	p.f.
IMPEDANCE	Z and phase
ACTIVE IMPED. COMPONENT	R
REACTIVE IMPEDANCE COMP.	X
RATIO	CT or VT or PT
POLARITY	CT or VT or PT
BURDEN	CT
SATURATION KNEE	CT

Phase angle measurement accuracy: 1°.
Frequency accuracy: 1 mHz.

External Inputs Measurement

Current measurements

- Two inputs: 20 mA AC or DC or 10 A AC.
- Accuracy: 0.5%

Voltage measurement

- Two inputs: 10 V or 600 V, AC or DC.
- Accuracy: 0.5%

Other measurements available on the T 2000, calculated from external inputs.

EXTERNAL INPUTS MEASUREMENTS:	
ACTIVE POWER	P
REACTIVE POWER	Q
APPARENT POWER	S
POWER FACTOR	p.f.
IMPEDANCE	Z and phase
ACTIVE IMPEDANCE COMP.	R
REACTIVE IMPEDANCE COMP.	X
FREQUENCY	f
PHASE ANGLE	IEXT to V AUX
PHASE ANGLE	VEXT to V AUX
RESISTANCE	R

Ratio Measurement Accuracy

Ratio: 0.1 to 9999; 0.5% typical; 1% max error.

Resistance

Up to 250 Ohm; 0.5% typical; 1% max error.

Oscilloscope Function

T 2000 has an additional oscilloscope function, that allows to display current and voltage waveforms.

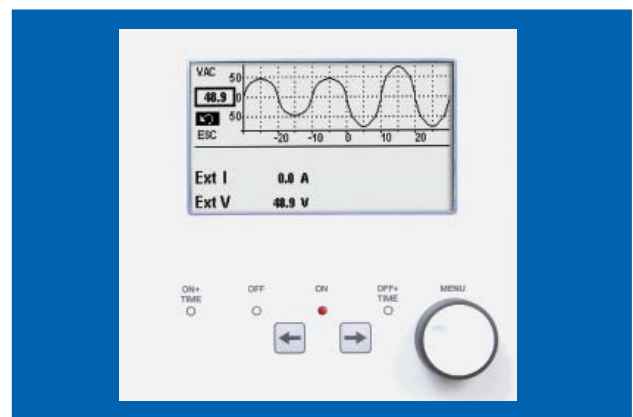

Graphic Display

The large graphic display has the following characteristics:

- Pixels: 240x128;
- backlight colour: white;
- LCD type: FSTN;
- View area: 135x80 mm.

Local Memory

Test results can be stored in the T 2000 local memory (up to 500 results may be stored). At the end of test, settings and test results can be transmitted to a PC provided with TDMS.

The software allows saving test results and examining them. Test settings can be stored and recalled from the memory. Up to 10 settings can be stored and recalled.

TDMS Software

When the PC is connected, settings can be created and transferred into T 2000 using TDMS. TDMS is a user friendly software that allows, via a graphical interface, to control the set-up of T 2000 and to download test results. TDMS is also a powerful report editor that allows to create professional test reports that can be exported in Access format.

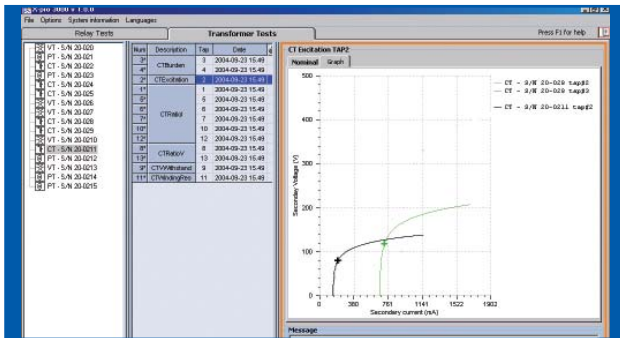

Software TDMS - CT test

Other characteristics

- . Interface: serial RS232; baud rate 57600 baud
- . Mains supply: 230 V \pm 10%; 50-60 Hz, or 110 V \pm 10%; 50-60 Hz; to be specified at order. (There are power reductions for mains voltage below 220V).
- . Dimensions: 455 (W) x 325 (D) x 290 (H) mm.
- . Weight: 31 kg.

The instrument comes complete with the following items:

- . User's manual;
- . Spare fuses (no. 5), T16A;
- . Software TDMS with user manual.
- . Set of connection cables, included in a suitable transport case with wheels and handle.

ACCESSORIES

Connection cable and test connectors

T 2000 is always supplied with a complete kit of testing cables:

- N. 2 High current connection cables, 100 sq. mm, 4 m long, for tests up to 800 A. Terminated on both sides with an high current connector (M+F).
- N. 2 High current connection cables, 100 sq. mm, 0.5 m long, for tests up to 800 A. Terminated on one side with an high current connector (M) and on the other side with an high current clamp.
- N. 2 High voltage connection cables, 4 m long, 5 kV, with earth screen. Terminated on one side with an HV connector, and on the other side with a safety banana plug.
- N. 2 Low current connection cables, 2.5 sq. mm, 10 m long. Terminated on both side with 4 mm banana plugs.
- N. 4 Clamps to connect low voltage or low current or measurements.

- N. 1 Cable for low voltage measurement connection, shielded, 10 m long. Terminated on one side with the measurement connector, and on the other side with two measurement clamps.
- N. 1 Cable for the 600 V measurement connection, shielded, 10 m long. Terminated on one side with three 4 mm banana plugs and on the other side with two clamps.
- N. 1 Grounding cable, 8 m long, terminated on one side with a 4 mm banana plug, and on the other side with an earth connection clamp.
- N. 4 Crocodiles for measurements connections (2 red, 2 black).
- N. 4 Measurement inputs cables (4 cables: 2 red and 2 black), 2 m long, terminated on both sides with a 4 mm banana plug.
- N. 1 Connection cables transport case.

OPTIONAL ACCESSORIES

Thermal printer

Optional thermal printer, for the printout of the V-I curve in the CT saturation test and other test results. Thermal Paper 112 mm wide.

Transit case

Heavy duty aluminium transit case with wheels; it allows delivering T 2000 with no concern about transport shocks. Heavy duty transport case in black plastics is also available.



Aluminium transport case



Plastics transport case

Current clamp

The current clamp allows to avoid opening the secondary current circuit when performing the primary test of CT burden.

OPTIONAL MODULES

High IDC Module - 400 A

The high DC current module allows the measurement of the low contact resistance of high voltage breakers or of joints. The option is connected to the high AC current output of T 2000; the current measurement is connected to the low DC current measurement input; the drop voltage is connected to the low voltage measurement input. DC current output is: 100 A steady; 200 A for 4 minutes; 400 A for 15 s. The selection of this function is performed via menu; the screen displays: test current; joint voltage; contact resistance. Resistance measurement ranges: 100.0 µOhm; 1.000, 10.00, 100.0 mOhm; 1.000 Ohm, auto-ranging. Connection cables are included with the option.

FT 1000 current filter

It is connected in series to the current output and guarantees a sinusoidal waveform also when testing current relays with heavily saturating burdens, that tend to distort the current waveform.

Earth resistance and resistivity test kit

The test of earth resistance and resistivity is included in T 2000 as a standard feature. The option is referred to the kit of connection cables and auxiliary spikes that allows executing these tests.

T 2000E

This model allows performing high current tests with more power. It is based upon the 1200 V high voltage generator. The corresponding changes to the high current output are the following.

CURRENT A	MAX POWER VA	MAX ON TIME s	OFF TIME min
100	850	CONT.	-
150	1200	15 min	30
200	1550	4 min	15
300	2050	15	5
400	2400	15	5
600	2600	5	3
800	2100	1	2

Weight: 37 Kg.

APPLICABLE STANDARDS

The test set conforms to the EEC directives regarding Electromagnetic Compatibility and Low Voltage instruments.

A) Electromagnetic Compatibility: Directive no. 2004/108/EC.

Applicable Standard : EN61326-1 + A1 + A2.

B) Low Voltage Directive: Directive n. 2006/95/EC.

Applicable standards, for a class I instrument, pollution degree 2, Installation category II:

- CEI EN 61010-1. In particular:

- Inputs/outputs protection: IP 2X - IEC 60529; 4X for the HV output.

- Operating temperature: 0 to 50 °C; storage: -20 °C to 70 °C.

- Relative humidity: 5 - 95% without condensing.

ORDERING INFORMATION

CODE	MODULE
10110	T 2000 - 3000 V OUTPUT - 230 V complete with TDMS software and test cable kit
20110	T 2000 - 3000 V OUTPUT - 115 V complete with TDMS software and test cable kit
30110	T 2000 - 1200 V OUTPUT - 230 V complete with TDMS software and test cable kit
40110	T 2000 - 1200 V OUTPUT - 115 V complete with TDMS software and test cable kit
50110	T 2000 E - 1200 V OUTPUT - 230 V complete with TDMS software and test cable kit
17102	Aluminium transport case
24102	Plastics transport case
16102	Current Clamp 1/1000 Max 100A
14102	Thermal Printer 112 mm
13102	High I DC module 400 A
26102	SU 3000 Safety device for the line impedance measurement
19102	Earth Resistance and Soil Resistivity Kit
16093	FT 1000

High Current Booster

The current output of T 2000 can be increased up to 2000 A with a new type of optional booster controlled by the T 2000 control unit. The BU 2000 option is an innovative design concept that allows to avoid the power losses due to long cables connections. To achieve this, the BU 2000 transformer is placed very close to the device under test (CT primary side, Circuit Breaker main contacts), thus avoiding losses on the high current cables. The BU 2000 is then connected with a long (20 m) low current cable to T 2000 unit. The option can use one, two or four transformers, as a function of the maximum test current and/or the test duration (see table below).

In case of 2 to 4 BU 2000 units, an Interposing Module is necessary.

Number of transformers	Weight Kg	Number of turns	Maximum current A	MAX ON s
1 MAIN	19.5	3	1000	100
		3	2000	6
1 MAIN +	29.5	2	1000	900
1 AUX +		2	2000	27
Interposing		2	3000	6
1 MAIN +	49.5	2	1000	900
3 AUX +		2	2000	27
Interposing		2	3000	6
		2	4000	2
		1	1000	INFINITE
		1	2000	900
		1	3000	100

BU 2000 SPECIFICATION

BU 2000 Main Module

- Supply voltage: 230 V.
- Voltage output (one turn): 0,91 V.
- Steady power: 1000 VA.
- Weight: 11 kg.
- Dimensions: external diameter 190 mm; height 120 mm.
- Connection of the transformer: by a cable, 20 m long, terminated with connectors on both sides.
- Output current metering: by a current transformer with ratio 1000//1. Accuracy class: 0.5%.
- Connection of the CT: by a cable, 20 m long, that includes a shunt, rated 0.1 Ohm, 25 W, accuracy 0.1%. The cable is terminated with a connector for the connection to the 10 V input of T 2000.

BU 2000 Auxiliary Module

- Supply voltage: 230 V.
- Voltage output (one turn): 0,89 V.
- Steady power: 1000 VA.
- Weight: 10 kg.
- Dimensions: external diameter 190 mm; height 120 mm.

The option is also provided with two high current screw-driven clamps for the connection to high bars and with four high current clamps for the connection to bars located into narrow places.



BU 2000 Interposing Module

- Mains connection: by a 64 A rated connector, provided.
- Power-on: by means of a circuit breaker rated 63 A.
- Coarse current adjustment: by means of a four-position selector switch.
- Connections to T 2000: power supply cord; Variable voltage output; auxiliary contact, timer START input.
- Capable to drive up to four transformers.
- Weight: 5 kg.
- Dimensions: 33 x 30 x 20 cm (WHD).

NOTE: in case of one transformer, the BU 2000 INTERPOSING MODULE is not necessary.

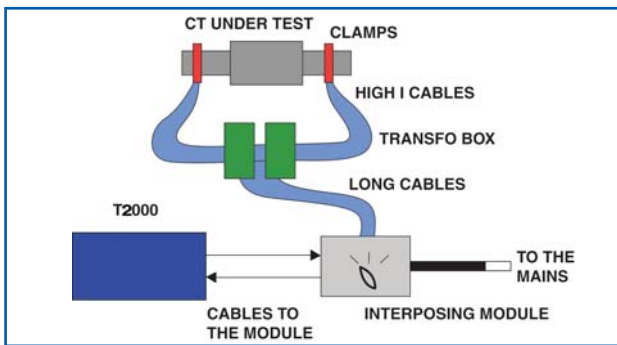

Interposing Module



Auxiliary Module



High current cable



Connecting cable

ORDERING INFORMATION

CODE	MODULE
50102	BU 2000 - External Advanced Booster up to 2000 A : (1) Main Module with high current clamps and high current cables, connecting cables.
51102	BU 2000 - External Advanced Booster up to 3000 A : Main Module with high current clamps, high current cables, Auxiliary Module (1), Interposing Module, connecting cables.
52102	BU 2000 - External Advanced Booster up to 4000 A : Main Module with high current clamps, high current cables, Auxiliary Modules (3), Interposing Module, connecting cables.
53102	BU 2000 - Interposing Module
54102	BU 2000 - Auxiliary Module
55102	Heavy Duty plastic transport case for BU 2000 (50102)
56102	Heavy Duty plastic transport case for BU 2000 (51102; 52102)



ISA Srl
Via Prati Bassi, 22
21020 Taino VA - Italy
Tel +39 0331 956081
Fax +39 0331 957091
Web site: www.isatest.com
E-Mail: isa@isatest.com

EN - T 2000 - 01/2012

The document is subject to change without notice. Always refer to our technical specification for more detailed information and as formal contract document.