

Substation Maintenance and Commissioning Test Equipment

- Multi function system for testing substation equipment such as: current, voltage and power transformers, all type of protection relays, energy meters and transducers
- Primary injection testing capabilities
- 3000 V AC high-pot test
- Generates up to 800 A (option: 2000 - 3000 - 4000A)
- Microhmmeter function (option): up to 400A DC
- Large graphic display
- Test results and settings are saved in the local memory
- RS232 interface for pc connection
- Compact and lightweight

T 3000 is a unique solution for all testing operations during commissioning and maintenance of substations, as it allows performing the test of relays of all types and of current and voltage transformers. It is also capable of testing energy meters and transducers. In addition, T 3000 incorporates a powerful multi-meter and phase angle meter, and oscilloscope functions.

A P P L I C A T I O N

The following table lists the tests that can be performed on Current Transformers (CT), Voltage Transformers (VT), Power Transformers (PT), Ground Grid.

N.	TEST	TEST DESCRIPTION
1	CT	Ratio, Voltage mode
2	CT	Ratio, polarity and burden, Current mode
3	CT	Burden; secondary side
4	CT	Excitation curve
5	CT	Winding or burden resistance
6	CT	Voltage withstand
7	CT	Polarity by impulses
8	VT	Ratio; polarity
9	VT	Burden, secondary side
10	VT	Ratio, electronic transformers
11	VT	Voltage withstand
12	VT	Secondary over-current protection
13	PT	Ratio per TAP
14	PT	Static and dynamic TAP Changer resistance test
15	GR	Earth resistance
16	GR	Soil resistivity



The table below lists the relays that can be set and tested by T 3000.

RELAY TYPE	IEEE NO	RELAY TYPE	IEEE NO
Distance (3 sets)	21	Frequency	81
Synchronizing	25	Frequency rate of change	81
Thermal	26	Motor protection	86
Over/under-voltage	27/59	Differential (pick-up)	87
Power, varmetric or wattmetric	32/92	Directional voltage	91
Under current	37	Tripping relay	94
Reverse phase current	46		
Instantaneous overcurrent	50	OTHER DEVICES	
Ground fault	50N	Voltage regulation	
Timed overcurrent	51	Timers	
Circuit Breaker	52	Transducers	
Power factor	55	Energy meters	
Directional overcurrent	67		
Directional ground fault	67N		
Automatic reclose	79		

Typical application

Test of Current Transformer

- CT RATIO AND POLARITY - VOLTAGE METHOD
OUTPUT: 90V, 250V or 3000 V AC.
MEASUREMENT: 10 V AC.

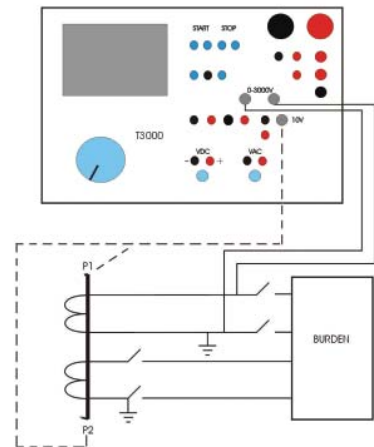
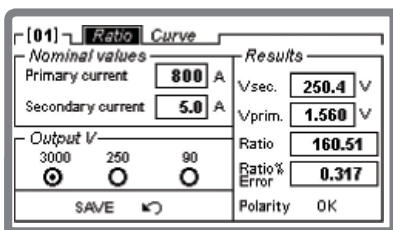

- CT RATIO, POLARITY AND BURDEN – CURRENT METHOD
OUTPUT: 800 A AC.
MEASUREMENTS: 10 A AC; 10 V AC.

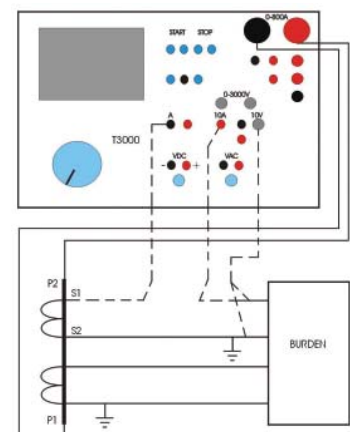
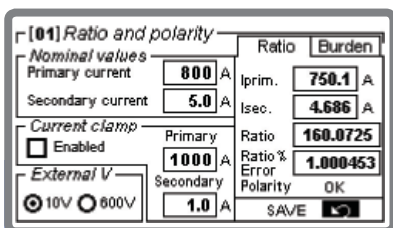

- CT BURDEN SECONDARY SIDE
OUTPUT: 10 A or 40 A AC.
MEASUREMENT: 10 V AC.

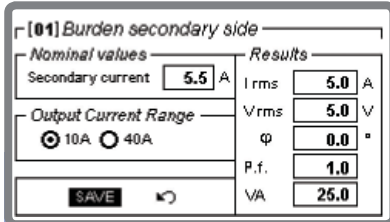

- CT EXCITATION CURVE
OUTPUT: 90V, 250V or 3000 V AC.
Internal measurement.

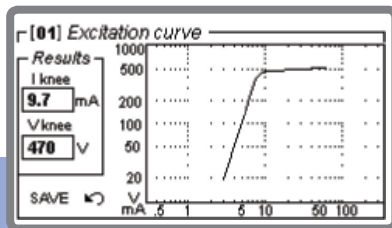
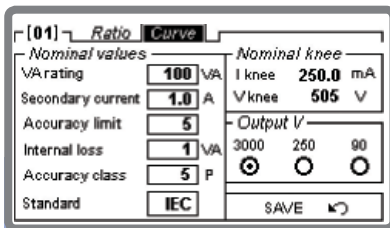

- WINDING RESISTANCE
OUTPUT: 6 A DC.
MEASUREMENT: 10 V DC.

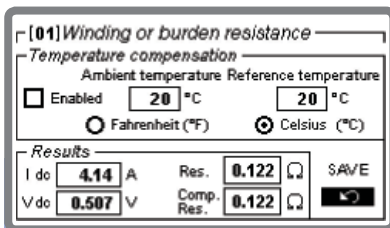

- VOLTAGE WITHSTAND
OUTPUT: 3000 V AC.
Internal measurement.

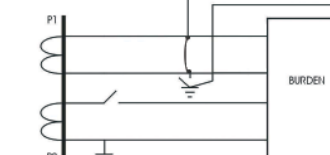
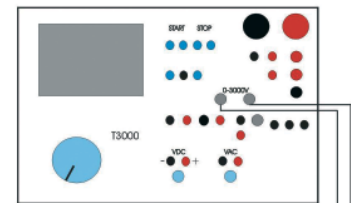
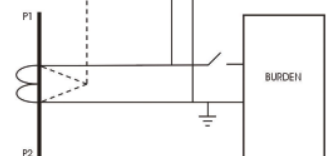
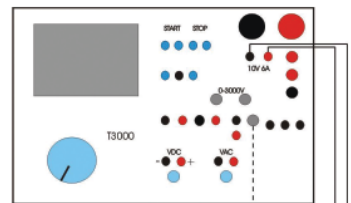
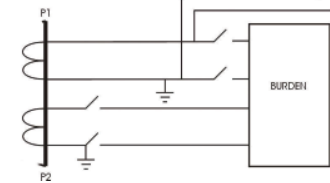
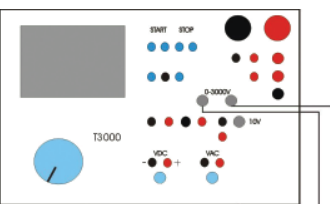
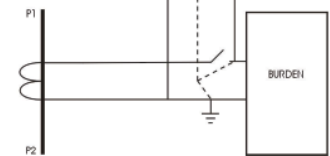
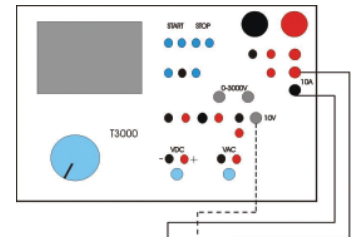
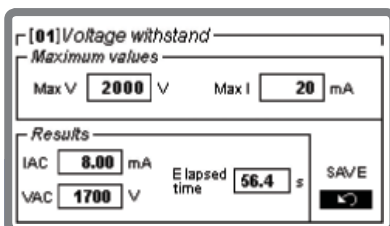

Typical application

Test of Voltage Transformer

- VT RATIO AND POLARITY

OUTPUT: 3000 V AC.

MEASUREMENT: LOW or HIGH AC VOLTAGE - 10 V AC OR 600 V AC.

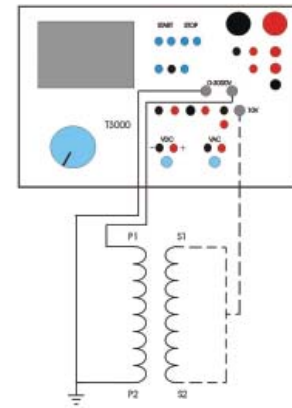
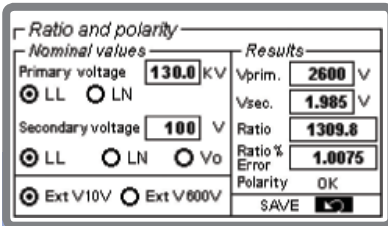

- VT BURDEN

OUTPUT: 10 A AC.

MEASUREMENT: LOW or HIGH AC VOLTAGE - 10 V AC OR 600 V AC.

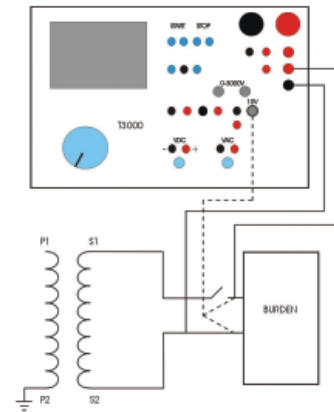
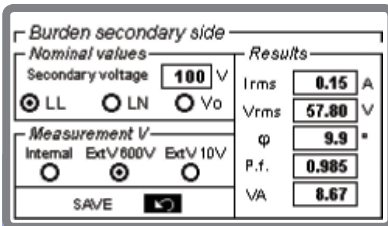

- VOLTAGE WITHSTAND

OUTPUT: 3000 V AC.

Internal measurement.

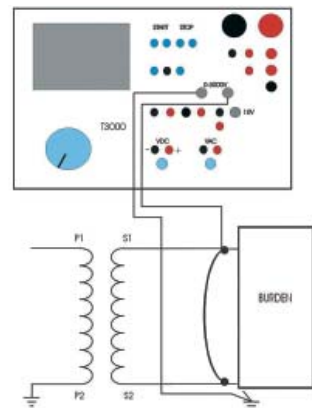
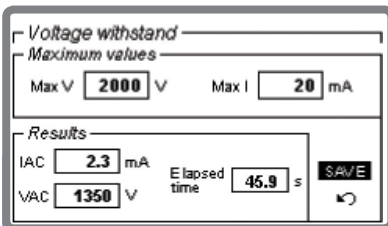

- RATIO OF ELECTRONIC VOLTAGE TRANSFORMERS

OUTPUT: 3000 V AC.

MEASUREMENT: 10 V AC.

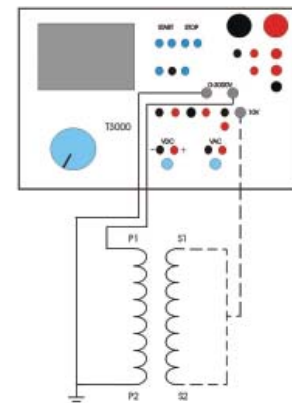
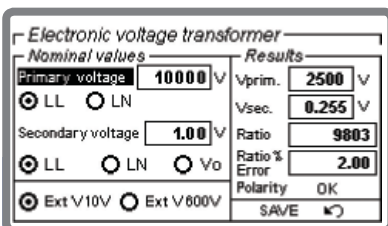

Typical application Power Transformer

- RATIO PER TAP
OUTPUT: 3000 V AC.
MEASUREMENT: LOW or HIGH AC VOLTAGE - 10 V AC OR 600 V AC.

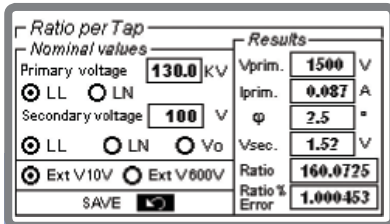

- STATIC AND DYNAMIC TAP CHANGER RESISTANCE TEST
OUTPUT: 6 A DC.
MEASUREMENT: 10 V DC.

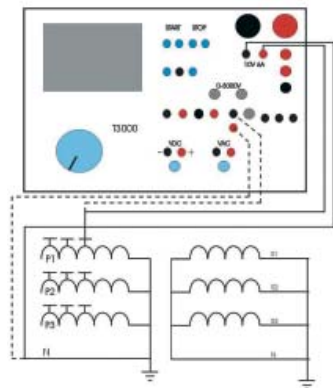
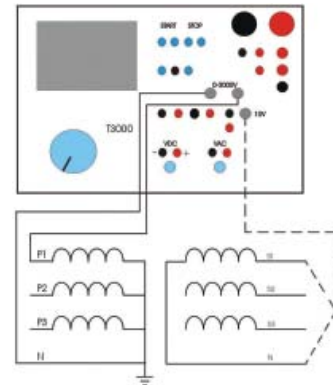
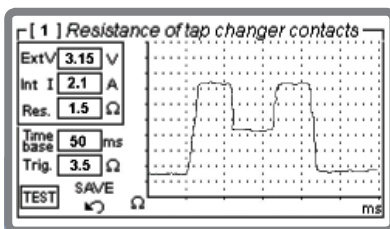

Typical application Relay Testing

- PRIMARY INJECTION
OUTPUT: 800 A.
INPUT: TIMER.

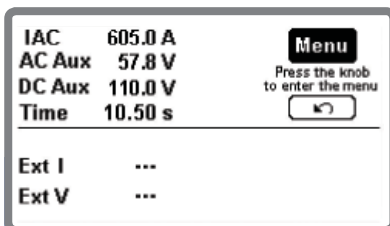

- SECONDARY INJECTION, OVER-CURRENT RELAYS
OUTPUT: 800 A, 40 A or 10 A.
INPUT: TIMER.

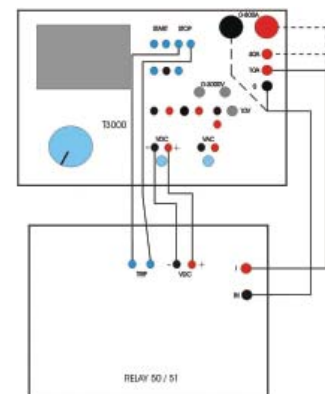
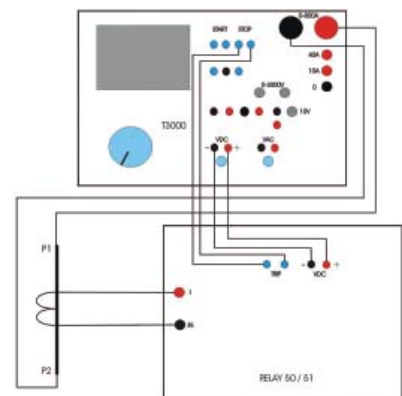
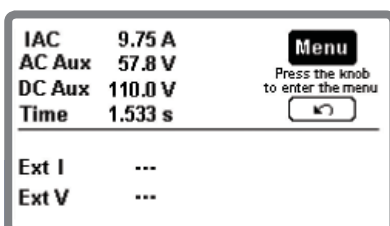

- SCOPE FUNCTION
OUTPUT: ANY.
INPUT: V and I.

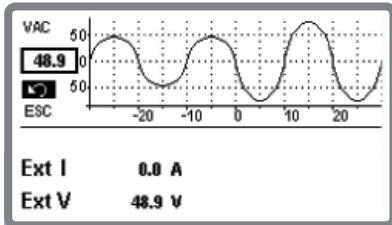

SYSTEM DESCRIPTION

T 3000 contains three independent generators:

- Main generator. It has six outputs: High AC current; Low AC current; Low DC current; Current impulses; High AC voltage; Low AC voltage.
- Auxiliary AC voltage generator: it generates an independent, phase adjustable AC voltage.
- Auxiliary DC voltage generator, to feed the relay under test.

All outputs are adjustable and metered on the large, graphic LCD display. With the multi-purpose control knob and the graphic LCD display it is possible to enter the MENU mode, that allows to control all functions, and makes T 3000 the most powerful testing device, with manual and automatic testing capabilities, and with the possibility to transfer test results to a PC via the RS232 interface. These results can be recorded, displayed and analysed by the powerful TDMS software, which operates with all WINDOWS versions, starting from WINDOWS 98 included. Additional features are:

- . Oscilloscope function: it is possible to display the current and voltage waveforms;
- . Two independent measurement inputs, for current and voltage and with High and Low inputs each; they allow measuring CT or VT outputs or any other source;
- . The optional thermal printer gives the immediate printout of the CT saturation curve and other test results;
- . An auxiliary output contact, that follows START and STOP inputs, allows simulating the circuit breaker.

The instrument is housed in a transportable aluminium box, which is provided with removable cover and handles for ease of transportation.

T 3000 Specification

Main Generator

The main generator has six outputs: High AC current; Low AC current; Low DC current; Current impulses; High AC voltage; Low AC voltage. Output adjustment is performed via a knob. The following specification applies to the separate usage of these outputs.

High AC current output

APPLICATION:

- . CT TESTING: RATIO, POLARITY, BURDEN
- . PRIMARY INJECTION
- . RELAY TESTING: ELECTRO-MECHANICAL (HIGH POWER) AND NUMERIC (LOW POWER)

CURRENT OUTPUT A	OUTPUT POWER VA	LOAD TIME s	RECOVERY TIME min
100	600	steady	-
150	800	15 min	30
200	1000	4 min	15
400	1600	15	5
600	2000	5	3
800	2000	1	2

Low AC current output

APPLICATION:

- . CT TESTING: BURDEN, SECONDARY SIDE
- . VT TESTING: OVERCURRENT PROTECTION
- . OVER-CURRENT RELAY TESTING

HIGH POWER RANGE

RANGE A AC	CURRENT OUTPUT A	OUTPUT POWER VA	MAX TEST DURATION s	RECOVERY TIME min
40	12	300	steady	-
	18		15 min	30
	24		4 min	15
	36	800	15	5
	48		5	3
	60	1000	1	2
10	5	400	steady	-
	7.5		15 min	30
	10	800	60	15
	15		30	10
	20	1000	15	5

LOW POWER RANGE

RANGE A AC	CURRENT OUTPUT A	OUTPUT POWER VA	MAX TEST DURATION s	RECOVERY TIME min
40	12	60	steady	-
	17		10 min	30
	23		60	10
10	36	60	1	2
	5		steady	-
	6		10 min	45
	7		60	2
	10		1.5	2

Low DC current output

APPLICATION:

- . CT TESTING: WINDING RESISTANCE, BURDEN RESISTANCE
- . PT TESTING: TAP-CHANGER CONTACT RESISTANCE

CURRENT OUTPUT A	LOAD RESISTANCE Ohm	OUTPUT POWER VA	MAX TEST DURATION min
6	0	0	steady
3	2	18	steady
1	8	8	steady

Current impulses output

APPLICATION:

- . CT TESTING: POLARITY TEST WITH IMPULSE METHOD
 - Current range: from 0 to 10 A peak.

High AC voltage output

Two version are available: 3000V or 1200V output.

APPLICATION:

- . CT TESTING: EXCITATION CURVE, VOLTAGE WITHSTAND
- . VT TESTING: RATIO, POLARITY, ELECTRONIC VOLTAGE TRANSFORMER
- . PT TESTING: RATIO PER TAP

3000 V version

APPLICATION: 1A CT'S

VOLTAGE OUTPUT V	CURRENT OUTPUT A	OUTPUT POWER VA	MAX TEST DURATION min
3000	0.2	600	steady
2500	0.6	1500	1

IN ALTERNATIVE

1200 V version

APPLICATION: 5A CT'S

VOLTAGE OUTPUT V	CURRENT OUTPUT A	OUTPUT POWER VA	MAX TEST DURATION min
1200	0.5	600	steady
1200	1.5	1800	1

Low AC voltage output

APPLICATION:

- . CT TESTING: RATIO WITH VOLTAGE METHOD, SATURATION CURVE

VOLTAGE OUTPUT V	CURRENT OUTPUT A	OUTPUT POWER VA	MAX TEST DURATION min
250	0.5	125	steady
220	1.15	250	3

Auxiliary AC Voltage

APPLICATION:

- . RELAY TESTING

RANGE V	MAX CURRENT mA
65	500
130	250
260	125

Phase angle sifter

- Phase angle adjustment: via the multi-function knob.
- Phase angle range: from 0° to 360°.
- Adjustment resolution: 1° (one degree).

Frequency & frequency rate of change generator

- Frequency range: 40 Hz to 500 Hz.
- Frequency adjustment: 1 mHz, via control knob.
- Frequency ROC range: from 0.01 Hz/s to 99.99 Hz/s.

Auxiliary DC Voltage

- DC voltage ranges: 130 V or 240 V.
- DC voltage power: 90 W at full range, continuous duty, with a current limit of 0.9 A @ 130 V and 0.45 A @ 240 V.

Timer

Available measurements:

- Timer start: at test start, or by an external contact;
 - Metering of elapsed time between START and STOP;
 - Current generation elapsed time.
 - Time can be metered as seconds or cycles.
- . Inputs: free of voltage or with voltage.
- . Programmable voltage threshold: 24 V or 80 V.
- . Metering range, in seconds: from 0 to 9.999 s; 10.00 to 99.99 s; 100.0 to 999.9 s; 1000 to 9999 s.
- . Metering range, in cycles: from 0 to 1000.0 cycles; from 1000 to 500,000 cycles.
- . Resolution: 0.1 cycles.
- Counting mode: this mode is foreseen for the test of energy meters. Maximum input frequency: 10 kHz.

Auxiliary Binary Output

Contact range: 5 A; 250 V AC; 120 V DC.

Measuring Section

Output measurements

Current and voltage AC and DC outputs measurement accuracy: $\pm 0.5\%$.

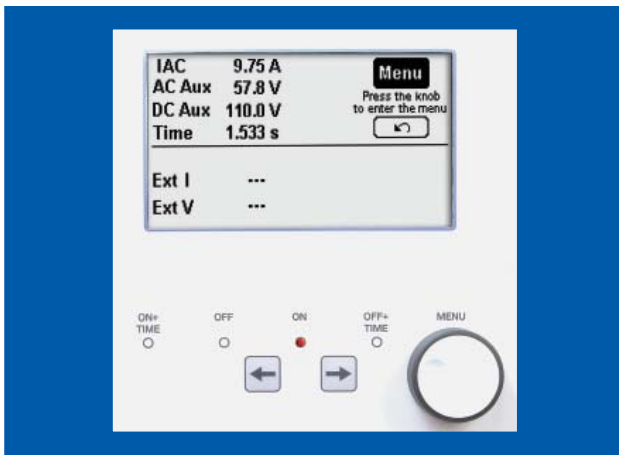

The following measurements are calculated from the T 3000 generated outputs:

OUTPUT MEASUREMENTS:

ACTIVE POWER	P
REACTIVE POWER	Q
APPARENT POWER	S
POWER FACTOR	p.f.
IMPEDANCE	Z and phase
ACTIVE IMPED. COMPONENT	R
REACTIVE IMPEDANCE COMP.	X
RATIO	CT or VT or PT
POLARITY	CT or VT or PT
BURDEN	CT
SATURATION KNEE	CT

Phase angle measurement accuracy: 1° .

Frequency accuracy: 1 mHz.

External Inputs Measurement

Current measurements

- . Two inputs: 20 mA AC or DC or 10 A AC.
- . Accuracy: 0.5%

Voltage measurement

- . Two inputs: 10 V or 600 V, AC or DC.
- . Accuracy: 0.5%

Other measurements available on the T 3000, calculated from external inputs.

EXTERNAL INPUTS MEASUREMENTS:

ACTIVE POWER	P
REACTIVE POWER	Q
APPARENT POWER	S
POWER FACTOR	p.f.
IMPEDANCE	Z and phase
ACTIVE IMPEDANCE COMP.	R
REACTIVE IMPEDANCE COMP.	X
FREQUENCY	f
PHASE ANGLE	IEXT to V AUX
PHASE ANGLE	VEXT to V AUX
RESISTANCE	R

Ratio Measurement Accuracy

Ratio: 0.1 to 9999; 0.5% typical; 1% max error.

Resistance

Up to 250 Ohm; 0.5% typical; 1% max error.

Oscilloscope Function

T 3000 has an additional oscilloscope function, that allows to display current and voltage waveforms.

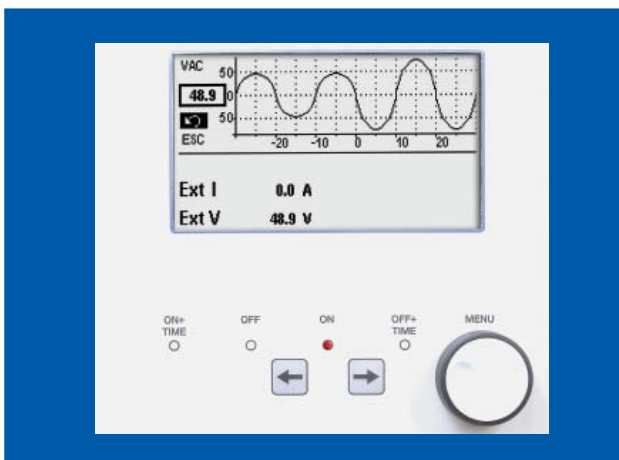

Graphic Display

The large graphic display has the following characteristics:

- Pixels: 240x128;
- Backlight colour: white;
- LCD type: FSTN;
- View area: 135x80 mm.

Local Memory

Test results can be stored in the T 3000 local memory (up to 500 results may be stored). At the end of test, settings and test results can be transmitted to a PC provided with TDMS.

The software allows saving test results and examining them. Test settings can be stored and recalled from the memory. Up to 10 settings can be stored and recalled.

TDMS Software

When the PC is connected, settings can be created and transferred into T 3000 using TDMS. TDMS is a user friendly software that allows via a graphical interface, to control the set-up of T 3000 and to download test results. TDMS is also a powerful report editor that allows to create professional test reports that can be exported in Access format.

Other Characteristics

- . Interface: serial RS232; baud rate 57600 baud
- . Mains supply: 230 V \pm 10%; 50-60 Hz, OR 110 V \pm 10%; 50-60 Hz; to be specified at order. (There are power reductions for mains voltage below 220V).
- . Dimensions: 455 (W) x 325 (D) x 290 (H) mm.
- . Weight: 34 kg.

ACCESSORIES

Connection cable and test connectors

- N. 1 Mains supply cable, 2 m long.
- N. 1 Interface cable for RS232 port.
- N. 2 High current connection cables, 100 sq. mm, 4 m long, for tests up to 800 A, terminated on one side with an high current male connector and the other side with a high current female connector.
- N. 2 High current connection cables, 100 sq. mm, 0.5 m long, for tests up to 800 A, terminated on one side with an high current male connector, and on the other side with a clamp.
- N. 2 High voltage connection cables, 4 m long, 5 kV, with earth screen, terminated on one side with an HV connector, and on the other side with safety banana plugs.
- N. 2 Low current connection cables, 10 sq. mm, 4 m long, terminated on one side with the high current connector, and on the other side with a 4 mm banana plug.
- N. 2 Low current connection cables, 2.5 sq. mm, 10 m long, terminated on both sides with a 4 mm banana plug.
- N. 8 Adapters for relay connection. Adapters are 20 cm long, and are terminated on one side with a banana socket and on other side with a pin terminator.
- N. 4 Clamps to connect low voltage or low current or measurements.
- N. 1 Cable for low voltage measurement connection, shielded, 10 m long, terminated on one side with the measurement connector, and on the other side with two clamps.
- N. 1 Cable for the 600 V measurement connection, shielded, 10 m long, terminated on one side with three 4 mm banana plugs, and on the other side with two clamps.
- N. 1 Grounding cable, 8 m long, terminated on one side with a 4 mm banana plug, and on the other side with an earth connection clamp.
- N. 6 Cables 2 meters long, terminated on both sides with banana plugs. Colours Black.

- N. 2 Cables 2 meters long, terminated on both sides with banana plugs. Colours Blue.
- N. 4 Cables 2 meters long, terminated on both sides with banana plugs. Colours Red.
- N. 4 Crocodile Clamps (2 black and 2 red).
- N. 1 Connection Cables Transport case.

The instrument comes complete also with the following items:

- . User's manual;
- . Spare fuses (no. 5), T16A;
- . Software TDMS with user manual.

OPTIONAL ACCESSORIES

Thermal printer

Optional thermal printer, for the printout of the V-I curve in the CT saturation test and other test results. Thermal Paper 112 mm wide.

Transit case

Heavy duty aluminium transit case with wheels; it allows delivering T 3000 with no concern about transport shocks. An heavy duty transport case in black plastic is also available.

Current clamp

The current clamp allows to avoid opening the secondary current circuit when performing the primary test of CT burden.

OPTIONAL MODULES

High IDC Module - 400 A

The high DC current module allows the measurement of the low contact resistance of high voltage breakers or of joints. The option is connected to the high AC current output of T 3000; the current measurement is connected to the low DC current measurement input; the drop voltage is connected to the low voltage measurement input. DC current output is: 100 A steady; 200 A for 4 minutes; 400 A for 15 s. The selection of this function is performed via menu; the screen displays: test current; joint voltage; contact resistance. Resistance measurement ranges: 100.0 µOhm; 1.000, 10.00, 100.0 mOhm; 1.000 Ohm, auto-ranging. Connection cables are included with the option.

D 1000 differential relay test module

The D 1000 differential relay test module allows for the test of the differential relay curve, and also of the harmonic restraint characteristic.

FT 1000 current filter

It is connected in series to the current output and guarantees a sinusoidal waveform also when testing current relays with heavily saturating burdens, that tend to distort the current waveform.

Earth resistance and resistivity test kit

The test of earth resistance and resistivity is included in T 3000 as a standard feature. The option is referred to the kit of connection cables and auxiliary spikes that allows executing these tests.

APPLICABLE STANDARDS

The test set conforms to the EEC directives regarding Electromagnetic Compatibility and Low Voltage instruments.

A) Electromagnetic Compatibility: Directive no. 2004/108/EC. Applicable Standard : EN61326-1 + A1 + A2.

B) Low Voltage Directive: Directive n. 2006/95/EC.

Applicable standards, for a class I instrument, pollution degree 2, Installation category II:

- . CEI EN 61010-1. In particular:
- . Inputs/outputs protection: IP 2X - IEC69529; IP 4X for HV output.
- . Operating temperature: 0 to 50 °C; storage: -20 °C to 70 °C.
- . Relative humidity: 5 - 95% without condensing.

ORDERING INFORMATION

CODE	MODULE
10102	T 3000 - 3000 V OUTPUT - 230 V complete with TDMS software and test cable kit
20102	T 3000 - 3000 V OUTPUT - 115 V complete with TDMS software and test cable kit
30102	T 3000 - 1200 V OUTPUT - 230 V complete with TDMS software and test cable kit
40102	T 3000 - 1200 V OUTPUT - 115 V complete with TDMS software and test cable kit
17102	Aluminium Transport case
24102	Heavy Duty plastic transport case
16102	Current Clamp 1/1000 Max 100A
14102	Thermal Printer 112 mm
13102	High I DC module 400 A
43102	Universal scanning head SH-2003
40093	D 1000 differential relay test module
19102	Earth Resistance and Soil Resistivity Kit
16093	FT 1000
26102	SU 3000 Safety grounding unit for line impedance measurement.

BU 2000

High Current Booster

The current output of T 3000 can be increased up to 4000 A with a new type of optional booster controlled by the T 3000 control unit. The BU 2000 option is an innovative design concept that allows to avoid the power losses due to long cables connections. To achieve this, the BU 2000 transformer is placed very close to the device under test (CT primary side, Circuit Breaker main contacts), thus avoiding losses on the high current cables. The BU 2000 is then connected with a long (20 m) low current cable to T 3000 unit. The option can use one, two or four transformers, as a function of the maximum test current and/or the test duration (see table below).

In case of 2 to 4 BU 2000 units, an Interposing Module is necessary.

Number of transformers	Weight kg	Number of turns	Maximum current A	MAX ON s
1 MAIN	19.5	3	1000	100
		3	2000	6
1 MAIN +	29.5	2	1000	900
1 AUX +		2	2000	27
Interposing		2	3000	6
1 MAIN +	49.5	2	1000	900
3 AUX +		2	2000	27
Interposing		2	3000	6
		2	4000	2
		1	1000	INFINITE
		1	2000	900
		1	3000	100

BU 2000 SPECIFICATION

BU 2000 Main Module

- Supply voltage: 230 V.
- Voltage output (one turn): 0,91 V.
- Steady power: 1000 VA.
- Weight: 11 kg.
- Dimensions: external diameter 190 mm; height 120 mm.
- Transformer supply: by a cable, 20 m long, terminated with connectors on both sides.
- Output current metering: by a current transformer with ratio 1000//1. Accuracy class: 0.5%.
- Connection of the CT: by a cable, 20 m long, that includes a shunt, rated 0.1 Ohm, 25 W, accuracy 0.1%. The cable is terminated with a connector for the connection to the 10 V input of T 3000.

BU 2000 Auxiliary Module

- Supply voltage: 230 V.
- Voltage output (one turn): 0,89 V.
- Steady power: 1000 VA.
- Weight: 10 kg.
- Dimensions: external diameter 190 mm; height 120 mm.

The option is also provided with a cable and two high current screw-driven clamps for the connection to high bars and with four high current clamps for the connection to bars located into narrow places.



BU 2000 Interposing Module

- Mains connection: by a 64 A rated connector, provided.
- Power-on: by means of a circuit breaker rated 63 A.
- Coarse current adjustment: by means of a four-position selector switch.
- Connections to T 3000: power supply cord; Variable voltage output; auxiliary contact, timer START input.
- Capable to drive up to four transformers.
- Weight: 5 kg;
- Dimensions: 33 x 30 x 20 cm (WHD).

NOTE: in case of one transformer, the BU 2000 INTERPOSING MODULE is not necessary.

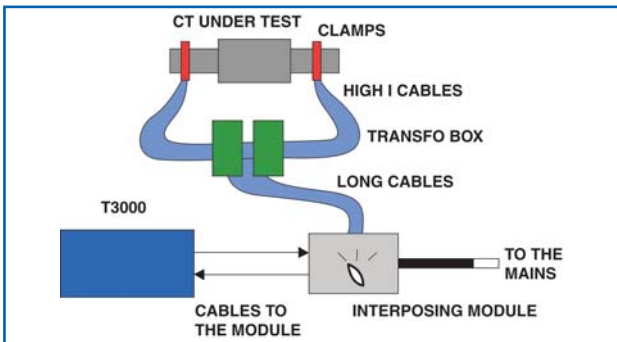

Interposing Module



Auxiliary Module



High current cable



Connecting cable

ORDERING INFORMATION

CODE	MODULE
50102	BU 2000 - External Advanced Booster up to 2000 A : (1) Main Module with high current clamps and high current cables, 20m connecting cables.
51102	BU 2000 - External Advanced Booster up to 3000 A : Main Module with high current clamps, high current cables, Auxiliary Module (1), Interposing Module, connecting cables.
52102	BU 2000 - External Advanced Booster up to 4000 A : Main Module with high current clamps, high current cables, Auxiliary Modules (3), Interposing Module, connecting cables.
53102	BU 2000 - Interposing Module
54102	BU 2000 - Auxiliary Module
55102	Heavy Duty plastic transport case for BU 2000 (50102)
56102	Heavy Duty plastic transport case for BU 2000 (51102; 52102)



ISA Srl
Via Prati Bassi, 22
21020 Taino VA - Italy
Tel +39 0331 956081
Fax +39 0331 957091
Web site: www.isatest.com
E-Mail: isa@isatest.com

EN - T 3000 - 12/2011

The document is subject to change without notice. Always refer to our technical specification for more detailed information and as formal contract document.